

# Quick Install Guide

GPL-1200-KIT G.hn Powerline Adapter Kit

## A

### Getting to Know Your G.hn Powerline Adapter

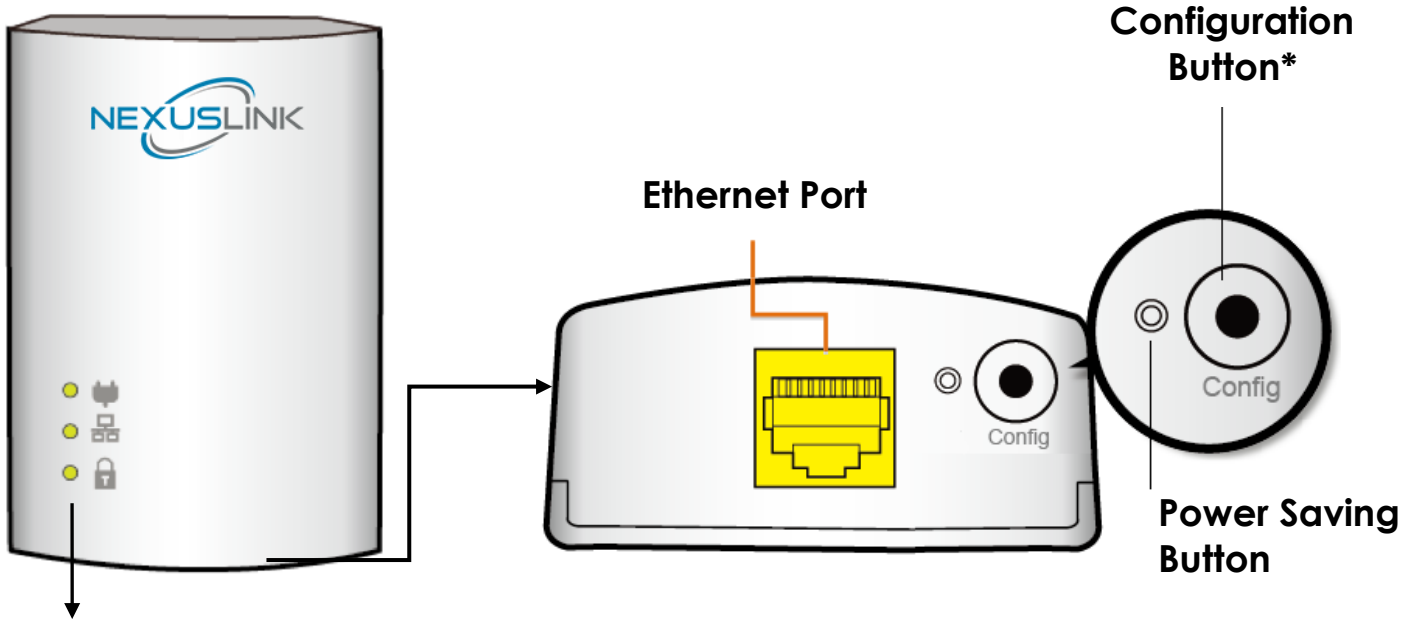

### LED Descriptions Below

\*Press for 10 seconds for Factory Reset

LED	Color	Mode	Description
<b>Connection</b> 	Green	On	The current connection (line rate) is more than 40Mbps.
	Orange	On	The current connection (line rate) is between 20Mbps and 40Mbps.
	Red	On	The current connection (line rate) is between 1Mbps and 20Mbps.
		Off	An Adapter connection does not exist.
		Blinking	Adapter is in Power Saving Mode (blinks twice every 5 seconds).
<b>Ethernet</b> 	Green	On	An Ethernet LAN connection is established.
		Blinking	Data over the Ethernet LAN connection is being transmitted.
		Off	An Ethernet LAN connection is not established.
<b>Security</b> 	Green	On	The Adapter is paired in Secure Mode.
		Blinking	The Adapter is in Configuration Mode.
		Off	The Adapter is not paired in Secure Mode .

# B

## Initial Powerline Adapter Setup

**NOTE: A minimum of two G.hn Powerline Adapters are required. Follow Steps 3-5 to add and pair additional G.hn Adapters to your network.**



1. Plug one Powerline Adapter into a power outlet near your Modem/Router.

**⚠** For maximum performance, please plug the Powerline Adapter directly into the wall outlet. Do not plug into a power strip or surge protector, as network performance could degrade significantly.



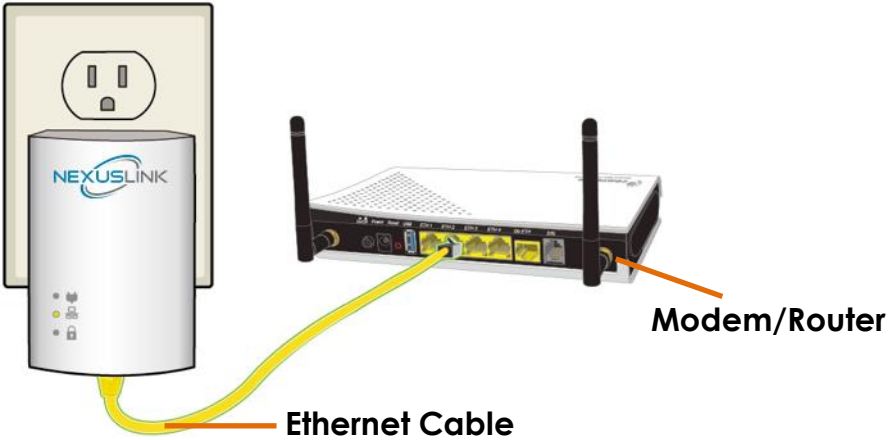



2. Connect this Powerline Adapter to your Modem/Router's LAN Port with an Ethernet (RJ-45) cable. Wait 10 seconds for the **Ethernet LED**  to light up **GREEN**, which indicates a connection is established. A flashing **GREEN** light indicates that the device is sending data.

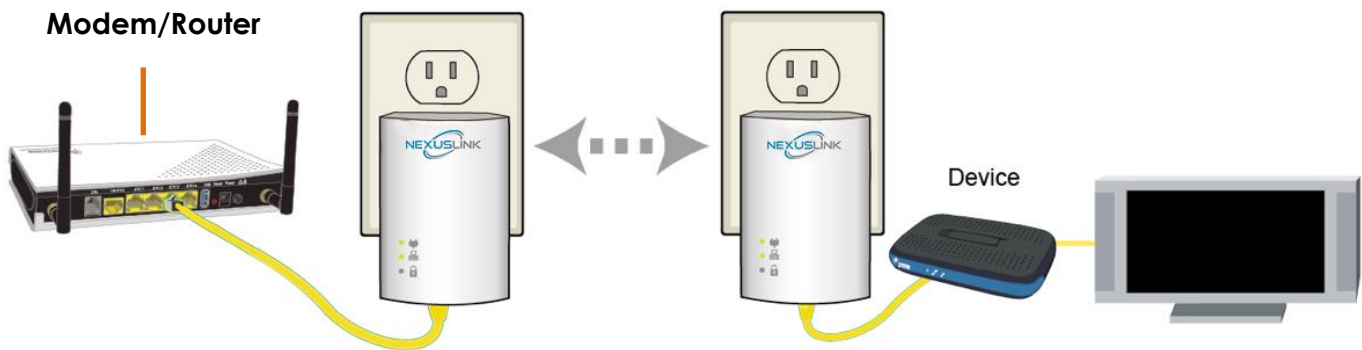



3. Plug the **other** Powerline Adapter into a power outlet near the Internet-enabled device (ex. TV, PC, STB, DVR, etc.).
4. Connect this Powerline Adapter to the Internet-enabled device (ex. TV, PC, STB, DVR, etc.) with an Ethernet (RJ-45) cable. The **Connection LED**  and **Ethernet LED**  on the front of both Powerline Adapters should be **GREEN**, which represents a strong connection.



## Pairing the Powerline Adapters

5. Press the **Config Button** for 3 seconds on one Adapter until you see the **Security LED**  start blinking **GREEN**. Then press the **Config Button** on the second Adapter until you see the **Security LED**  start blinking **GREEN**. The **Security LED**  and the **Connection LED**  should be solid **GREEN** on both Adapters when they are successfully paired.

Note: If you are adding to an existing G.hn Powerline network, then press the **Config Button** on any Adapter in the existing G.hn Powerline network for 3 seconds until you see the **Security LED**  start blinking **GREEN**. Then press the **Config Button** on the Powerline Adapter you are adding. The **Security LED**  and the **Connection LED**  will light up **GREEN** on all adapters within the G.hn Powerline network.

6. Repeat Steps 3 to 5 to add additional Powerline Adapters. Please note that up to 16 devices can be connected within a Powerline G.hn Network.

**You Have Successfully Set Up Your G.hn Powerline Network!**



## Troubleshooting

The following information should help you diagnose basic setup or installation problems.

**Connection LED**  **is OFF:** The **Connection LED** shows that the Powerline Adapter is connected to the G.hn Network. If the indicator is off, then plug both Powerline Adapters that you are attempting to pair into power outlets that are located within the same room. The **Connection LED** should light up **GREEN**. If not, then press the **Config Button** on each adapter for more than 10 seconds. Afterwards, you can plug the units back into their original location.

**Ethernet LED**  **is OFF:** If the **Ethernet LED** fails to light up, check that the LAN port of the Powerline Adapter is connected firmly to the LAN port of the other device. To check the condition of the Ethernet cable, use another cable to test the same connection.

**Security LED**  **is OFF:** If the **Security LED** is off, then it means the Powerline Adapter is not securely paired. Press the **Config Button** on the Powerline Adapter for 3 seconds until you see the **Security LED**

start flashing **GREEN**. Repeat this on the other Powerline Adapter. The **Security LED** and the **Connection LED** will light up **GREEN** on both adapters. This means the adapters are now securely paired and have a strong connection.

To join an existing G.hn Powerline network, press the **Config Button** on any Powerline Adapter in the existing G.hn Powerline network for 3 seconds until you see the **Security LED** start flashing **GREEN**. Then press the **Config Button** on the **additional** Powerline Adapter. The **Security LED** and the **Connection LED** will light up **GREEN** on both adapters.

\*If you have tried the above and are still experiencing problems, you can reset all devices to factory default by pushing the **Config Button** for more than 10 seconds (until all the LEDs of the device blink).

Power Specifications:

- I/P: 100-240Vac, 50/60Hz, 15A



#### **WARNING**

- For indoor use only
- Do NOT open the casing
- Do NOT use near water
- Do NOT insert sharp objects into the adapter's socket

#### **ADDITIONAL HELP:**



Visit the GPL-1200-KIT Product Webpage for additional resources such as a User Manual, FAQs, and/or Videos.

Link: [nexuslinkusa.com/product/gpl-1200-kit](https://nexuslinkusa.com/product/gpl-1200-kit)

#### **Support:**



Call: (855) 337-6750



Email: [Support@NexusLinkUSA.com](mailto:Support@NexusLinkUSA.com)